

INSTALLATION INSTRUCTION

Cloud - Bath

WS-3418



MODERN FORMS
A WAC LIGHTING COMPANY

WARNING

IMPORTANT: NEVER attempt any work without shutting off the electricity.

- Read all instructions before installing.
- System is intended for installation by a qualified electrician in accordance with the National Electrical Code and local regulations.
- Go to the main fuse box, or circuit breaker. Place the main power switch in the "OFF" position and unscrew the fuse(s) or switch "OFF" the circuit breaker switch(es) that control the power to the fixture or room that you are working on.
- Place the wall switch in the "OFF" position.

CAUTION

- All parts must be used as indicated in these instructions. Do not substitute any parts, leave parts out, or use any parts that are worn out or broken. Failure to follow this instruction could invalidate the ETL/CETL listing of this fixture.
CAUTION When handling the fixture, do not apply pressure to the LEDs. Hold the fixture by the base only.

AVERTISSEMENT

IMPORTANT : Coupez l'électricité avant TOUTE manipulation.

- Lisez toutes les instructions avant d'installer.
- Système est destiné à être installé par un électricien qualifié en conformité avec le code national de l'électricité et les règlements locaux.
- Accédez au panneau central de disjoncteurs ou de fusibles de votre demeure et placez l'interrupteur principal en position d'arrêt (« OFF »).
- Placez l'interrupteur mural en position d'arrêt (« OFF »).

MISE EN GARDE

- Toutes les pièces doivent être utilisées tel qu'il est indiqué dans ces instructions. Ne remplacez pas les pièces, n'en laissez pas de côté et ne les utilisez pas si elles sont usées ou brisées. Le non-respect de ces instructions peut annuler l'homologation ETL/CETL du luminaire. MISE EN GARDE Ors de la manipulation de l'appareil, ne pas appliquer de pression à la LED, tenir l'appareil par la seule base.

ADVERTENCIA









IMPORTANTE: NUNCA intente hacer trabajos sin desconectar el suministro eléctrico.

- Lea y comprenda todas las instrucciones e ilustraciones por completo antes de proceder con el ensamblaje e instalación de esta lámpara.
- Sistema está diseñado para ser instalado por un electricista calificado, de acuerdo con el código eléctrico nacional y las normas locales.
- Diríjase a la caja de fusibles o a la caja del interruptor de circuito principal en su hogar. Coloque el interruptor de alimentación principal en la posición "OFF" (APAGADO).
- Coloque el interruptor de la pared en la posición "OFF" (APAGADO).

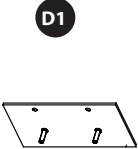
PRECAUCIÓN

- Todas las piezas deben usarse como lo indican estas instrucciones. No reemplace las piezas, no omita piezas durante la instalación ni utilice piezas gastadas o rotas. El incumplimiento de esta indicación podría invalidar la calificación ETL/CETL esta lámpara. PRECAUCIÓN Al manipular el aparato, no aplique presión a los LED, mantenga el aparato en la base sólo.

HARDWARE

									
Wire Connector Qty: 3pcs	Junction Box Screw Qty: 2pcs + 1 Extra	Set Screw Qty: 4pcs + 1 Extra	Glass Holder Qty: 2pcs	Wood Screw Qty: 2pcs + 1 Extra	Mounting Anchor Qty: 2pcs + 1 Extra	Plastic Washer Qty: 4pcs + 1 Extra	Iron Washer Qty: 4pcs + 1 Extra	Hex flange nut Qty: 4pcs + 1 Extra	Knurled Nut Qty: 1 Extra

Modern Forms

www.modernforms.com
Phone (800) 526.2588 • Fax (800) 526.2585

Headquarters/Eastern Distribution Center

44 Harbor Park Drive • Port Washington, NY 11050
Phone (516) 515.5000 • Fax (516) 515.5050

Western Distribution Center

1750 Archibald Ave • Ontario, CA 91761
Phone (800) 526.2588 • Fax (800) 526.2585



INSTALLATION INSTRUCTION

Cloud - Bath

WS-3418



MODERN FORMS
A WAC LIGHTING COMPANY

Fig. 1

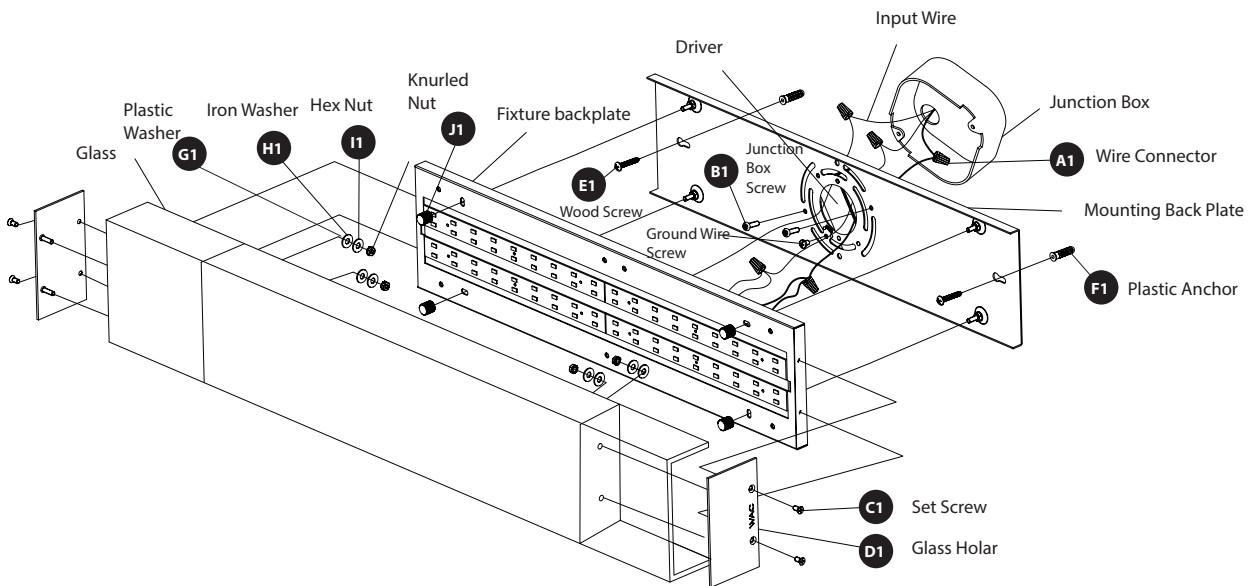

PREPARATION

- Shut off the power at the circuit breaker and remove existing fixture, including the mounting hardware.
- Carefully unpack your new fixture and lay out all the parts on a clear area. Be careful not to lose any small parts necessary for installation.

CONNECTING THE WIRES (FIG. 2)

1. Remove the knurled nut (J1) and fixture back plate from the mounting back plate. Remove wire connectors (A1).
2. Connect the Driver's input wires to junction box wires as shown in **Fig. 2**, making sure that all wire connectors are secured. If your outlet box has a green or bare copper ground wire, connect the fixture's ground wire to it. Otherwise, connect the fixture's ground wire directly to the back plate using the green screw provided. After wires are connected, tuck them carefully inside the junction box.

***Requires Driver to be recessed within the junction box**

MOUNTING THE FIXTURE (FIG. 2)

3. Secure the mounting back plate to the junction box using junction box screws (B1). The side of the mounting back plate marked "GND" must face out.
4. Secure the mounting back plate to wall using the wood screws (E1) and the plastic anchors (F1).
5. Secure the fixture back plate onto mounting back plate with knurled nut (J1).

COMPLETING THE INSTALLATION (FIG. 1)

6. Secure the glass holder (D1) to the glass using plastic washer (G1), iron washer (H1) and hex nut (I1).
7. Place the glass onto the fixture back plate and secure with set screw (C1).

Fig. 2

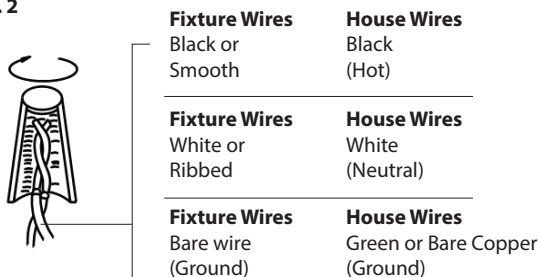

Modern Forms
www.modernforms.com
Phone (800) 526.2588 • Fax (800) 526.2585

Headquarters/Eastern Distribution Center
44 Harbor Park Drive • Port Washington, NY 11050
Phone (516) 515.5000 • Fax (516) 515.5050

Western Distribution Center
1750 Archibald Ave • Ontario, CA 91761
Phone (800) 526.2588 • Fax (800) 526.2585

